

Additional modules for later attachment to switches 41300/41600/71300

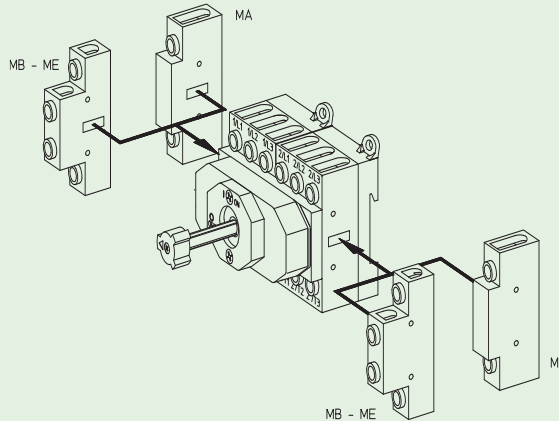

| Switching programme | | Type | Order code no. | |
|---|--------------|--|--|--|
| module left | module right | | front mounting | base mounting |
| Neutral contact module MA early make/late break | | H216 H220 H226 H233 B240 B250 B263 H406 H408 H410 H412 | MAH2-16A01 MAH2-20A01 MAH2-26A01 MAH2-33A01 MAB2-40A01 MAB2-50A01 MAB2-63A01 MAH4-06A01 MAH4-08A01 MAH4-10A01 MAH4-12A01 | MAH2-16A02 MAH2-20A02 MAH2-26A02 MAH2-33A02 MAB2-40A02 MAB2-50A02 MAB2-63A02 MAH4-06A02 MAH4-08A02 MAH4-10A02 MAH4-12A02 |
| | | | | |
| N-terminal MF | | H216 H220 H226 H233 B240 B250 B263 H406 H408 H410 H412 | MFH2-00A01 MFH2-00A01 MFH2-00A01 MFH2-00A01 MFB2-00A01 MFB2-00A01 MFB2-00A01 MFH4-00A01 MFH4-00A01 MFH4-00A01 MFH4-00A01 | MFH2-00A02 MFH2-00A02 MFH2-00A02 MFH2-00A02 MFB2-00A02 MFB2-00A02 MFB2-00A02 MFH4-00A02 MFH4-00A02 MFH4-00A02 MFH4-00A02 |
| | | | | |
| PE-terminal MG | | H216 H220 H226 H233 B240 B250 B263 H406 H408 H410 H412 | MGH2-00A01 MGH2-00A01 MGH2-00A01 MGH2-00A01 MGB2-00A01 MGB2-00A01 MGB2-00A01 MGH4-00A01 MGH4-00A01 MGH4-00A01 MGH4-00A01 | MGH2-00A02 MGH2-00A02 MGH2-00A02 MGH2-00A02 MGB2-00A02 MGB2-00A02 MGB2-00A02 MGH4-00A02 MGH4-00A02 MGH4-00A02 MGH4-00A02 |
| | | | | |
| Main contact module MO | | H216 H220 H226 H233 B240 B250 B263 H406 H408 H410 H412 | MOH2-16A01 MOH2-20A01 MOH2-26A01 MOH2-33A01 MOB2-40A01 MOB2-50A01 MOB2-63A01 MOH4-06A01 MOH4-08A01 MOH4-10A01 MOH4-12A01 | MOH2-16A02 MOH2-20A02 MOH2-26A02 MOH2-33A02 MOB2-40A02 MOB2-50A02 MOB2-63A02 MOH4-06A02 MOH4-08A02 MOH4-10A02 MOH4-12A02 |
| | | | | |



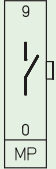
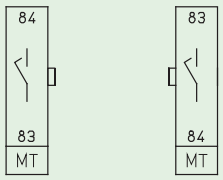
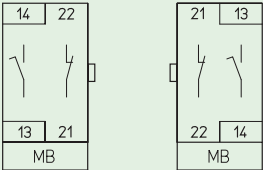
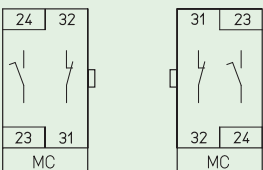
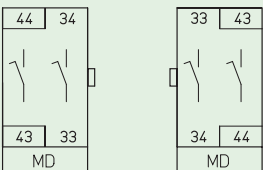

Disconnect Switches

Technical Information Additional modules

Additional modules for later attachment to switches 41300/41600/71300

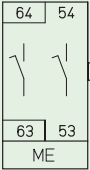
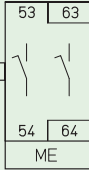
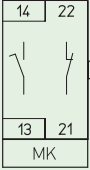
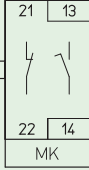
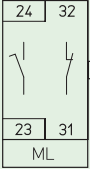
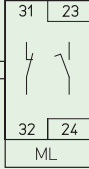
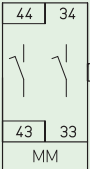
| Switching programme | | Type | Order code no. | |
|---|--------------|------------|----------------|---------------|
| module left | module right | | front mounting | base mounting |
| Main contact module MP | | | | |
|  | | H216 | MPH2-16A01 | MPH2-16A02 |
| | | H220 | MPH2-20A01 | MPH2-20A02 |
| | | H226 | MPH2-26A01 | MPH2-26A02 |
| | | H233 | MPH2-33A01 | MPH2-33A02 |
| | | B240 | MPB2-40A01 | MPB2-40A02 |
| | | B250 | MPB2-50A01 | MPB2-50A02 |
| | | B263 | MPB2-63A01 | MPB2-63A02 |
| | | H406 | MPH4-06A01 | MPH4-06A02 |
| | | H408 | MPH4-08A01 | MPH4-08A02 |
| | | H410 | MPH4-10A01 | MPH4-10A02 |
| H412 | MPH4-12A01 | MPH4-12A02 | | |
| Main contact module MT | | | | |
| 1 early make/late break 20A | | H216 | MTH2-20A01 | MTH2-20A02 |
|  | | H220 | MTH2-20A01 | MTH2-20A02 |
| | | H226 | MTH2-20A01 | MTH2-20A02 |
| | | H233 | MTH2-20A01 | MTH2-20A02 |
| | | B240 | MTB2-20A01 | MTB2-20A02 |
| | | B250 | MTB2-20A01 | MTB2-20A02 |
| | | B263 | MTB2-20A01 | MTB2-20A02 |
| | | H406 | MTH4-20A01 | MTH4-20A02 |
| | | H408 | MTH4-20A01 | MTH4-20A02 |
| | | H410 | MTH4-20A01 | MTH4-20A02 |
| | | H412 | MTH4-20A01 | MTH4-20A02 |
| Auxiliary contact module MB | | | | |
| 1 n/o late make/early break + 1 n/c | | H216 | MBH2-11A01 | MBH2-11A02 |
|  | | H220 | MBH2-11A01 | MBH2-11A02 |
| | | H226 | MBH2-11A01 | MBH2-11A02 |
| | | H233 | MBH2-11A01 | MBH2-11A02 |
| | | B240 | MBH4-11A01 | MBH4-11A02 |
| | | B250 | MBH4-11A01 | MBH4-11A02 |
| | | B263 | MBH4-11A01 | MBH4-11A02 |
| | | H406 | MBH4-11A01 | MBH4-11A02 |
| | | H408 | MBH4-11A01 | MBH4-11A02 |
| | | H410 | MBH4-11A01 | MBH4-11A02 |
| | | H412 | MBH4-11A01 | MBH4-11A02 |
| Auxiliary contact module MC | | | | |
| 1 n/o late make/early break + 1 n/c | | H216 | MCH2-11A01 | MCH2-11A02 |
|  | | H220 | MCH2-11A01 | MCH2-11A02 |
| | | H226 | MCH2-11A01 | MCH2-11A02 |
| | | H233 | MCH2-11A01 | MCH2-11A02 |
| | | B240 | MCH4-11A01 | MCH4-11A02 |
| | | B250 | MCH4-11A01 | MCH4-11A02 |
| | | B263 | MCH4-11A01 | MCH4-11A02 |
| | | H406 | MCH4-11A01 | MCH4-11A02 |
| | | H408 | MCH4-11A01 | MCH4-11A02 |
| | | H410 | MCH4-11A01 | MCH4-11A02 |
| | | H412 | MCH4-11A01 | MCH4-11A02 |
| Auxiliary contact module MD | | | | |
| 2 n/o late make/early break | | H216 | MDH2-20A01 | MDH2-20A02 |
|  | | H220 | MDH2-20A01 | MDH2-20A02 |
| | | H226 | MDH2-20A01 | MDH2-20A02 |
| | | H233 | MDH2-20A01 | MDH2-20A02 |
| | | B240 | MDH4-20A01 | MDH4-20A02 |
| | | B250 | MDH4-20A01 | MDH4-20A02 |
| | | B263 | MDH4-20A01 | MDH4-20A02 |
| | | H406 | MDH4-20A01 | MDH4-20A02 |
| | | H408 | MDH4-20A01 | MDH4-20A02 |
| | | H410 | MDH4-20A01 | MDH4-20A02 |
| | | H412 | MDH4-20A01 | MDH4-20A02 |

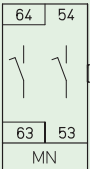
Additional modules for later attachment to switches 41300/41600/71300

| Switching programme | | Type | Order code no. | |
|--|---|--|--|--|
| module left | module right | | front mounting | base mounting |
| Auxiliary contact module ME 2 n/o late make/early break | | H216 H220 H226 H233 B240 B250 B263 H406 H408 H410 H412 | MEH2-20A01 MEH2-20A01 MEH2-20A01 MEH2-20A01 MEH4-20A01 MEH4-20A01 MEH4-20A01 MEH4-20A01 MEH4-20A01 MEH4-20A01 MEH4-20A01 MEH4-20A01 | MEH2-20A02 MEH2-20A02 MEH2-20A02 MEH2-20A02 MEH4-20A02 MEH4-20A02 MEH4-20A02 MEH4-20A02 MEH4-20A02 MEH4-20A02 MEH4-20A02 MEH4-20A02 |
|  |  | | | |
| Auxiliary contact module MK 1 n/o late make/early break + 1 n/c Contacts with gold plating 5 µm | | H216 H220 H226 H233 B240 B250 B263 H406 H408 H410 H412 | MKH2-11A01 MKH2-11A01 MKH2-11A01 MKH2-11A01 MKH4-11A01 MKH4-11A01 MKH4-11A01 MKH4-11A01 MKH4-11A01 MKH4-11A01 MKH4-11A01 MKH4-11A01 | MKH2-11A02 MKH2-11A02 MKH2-11A02 MKH2-11A02 MKH4-11A02 MKH4-11A02 MKH4-11A02 MKH4-11A02 MKH4-11A02 MKH4-11A02 MKH4-11A02 MKH4-11A02 |
|  |  | | | |
| Auxiliary contact module ML 1 n/o late make/early break + 1 n/c Contacts with gold plating 5 µm | | H216 H220 H226 H233 B240 B250 B263 H406 H408 H410 H412 | MLH2-11A01 MLH2-11A01 MLH2-11A01 MLH2-11A01 MLH4-11A01 MLH4-11A01 MLH4-11A01 MLH4-11A01 MLH4-11A01 MLH4-11A01 MLH4-11A01 MLH4-11A01 | MLH2-11A02 MLH2-11A02 MLH2-11A02 MLH2-11A02 MLH4-11A02 MLH4-11A02 MLH4-11A02 MLH4-11A02 MLH4-11A02 MLH4-11A02 MLH4-11A02 MLH4-11A02 |
|  |  | | | |
| Auxiliary contact module MM 2 n/o late make/early break Contacts with gold plating 5 µm | | H216 H220 H226 H233 B240 B250 B263 H406 H408 H410 H412 | MMH2-20A01 MMH2-20A01 MMH2-20A01 MMH2-20A01 MMH4-20A01 MMH4-20A01 MMH4-20A01 MMH4-20A01 MMH4-20A01 MMH4-20A01 MMH4-20A01 MMH4-20A01 | MMH2-20A02 MMH2-20A02 MMH2-20A02 MMH2-20A02 MMH4-20A02 MMH4-20A02 MMH4-20A02 MMH4-20A02 MMH4-20A02 MMH4-20A02 MMH4-20A02 MMH4-20A02 |
|  |  | | | |
| Auxiliary contact module MN 2 n/o late make/early break Contacts with gold plating 5 µm | | H216 H220 H226 H233 B240 B250 B263 H406 H408 H410 H412 | MNH2-20A01 MNH2-20A01 MNH2-20A01 MNH2-20A01 MNH4-20A01 MNH4-20A01 MNH4-20A01 MNH4-20A01 MNH4-20A01 MNH4-20A01 MNH4-20A01 MNH4-20A01 | MNH2-20A02 MNH2-20A02 MNH2-20A02 MNH2-20A02 MNH4-20A02 MNH4-20A02 MNH4-20A02 MNH4-20A02 MNH4-20A02 MNH4-20A02 MNH4-20A02 MNH4-20A02 |
|  |  | | | |

Disconnect Switches

Technical Information Additional modules

Additional modules for later attachment to switches 41300/41600/71300

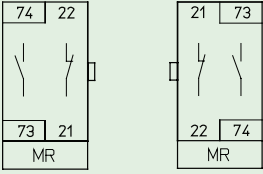
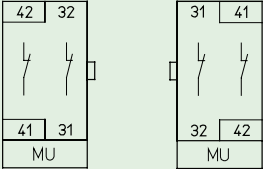
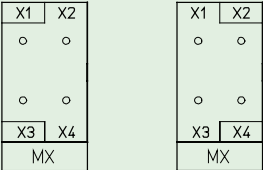
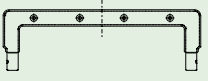
| Switching programme | | Type | Order code no. front mounting | Order code no. base mounting |
|--|--------------|--|--|--|
| module left | module right | | | |
| Auxiliary contact module MR 1 n/o + 1 n/c  | | H216 H220 H226 H233 B240 B250 B263 | MRH2-11A01 MRH2-11A01 MRH2-11A01 MRH2-11A01 MRB2-11A01 MRB2-11A01 MRB2-11A01 | MRH2-11A02 MRH2-11A02 MRH2-11A02 MRH2-11A02 MRB2-11A02 MRB2-11A02 MRB2-11A02 |
| Auxiliary contact module MU 2 n/c  | | H216 H220 H226 H233 B240 B250 B263 | MUH2-02A01 MUH2-02A01 MUH2-02A01 MUH2-02A01 MUB2-02A01 MUB2-02A01 MUB2-02A01 | MUH2-02A02 MUH2-02A02 MUH2-02A02 MUH2-02A02 MUB2-02A02 MUB2-02A02 MUB2-02A02 |
| Terminal point module MX 4 terminal bases 2,5 mm ²  | | H216 H220 H226 H233 B240 B250 B263 H406 H408 H410 H412 | — — — — — — — — — — | MXH2-04A02 MXH2-04A02 MXH2-04A02 MXH2-04A02 MXH4-04A02 MXH4-04A02 MXH4-04A02 MXH4-04A02 MXH4-04A02 MXH4-04A02 |
| Neutral terminal link (insulated) Link to connect the neutral contact modules (MA) on the 71400 Changeover Switch  | | H200 B200 H400 | 224234 224301 404111 | 224234 224303 404111 |